

On the Geometry of Metastable Supersymmetry Breaking

Matthew Buican, Dmitry Malyshev¹, and Herman Verlinde

*Physics Department, Princeton University,
Joseph Henry Laboratories, Princeton NJ 08544*

Abstract

We give a concise geometric recipe for constructing D-brane gauge theories that exhibit metastable SUSY breaking. We present two simple examples in terms of branes at deformed CY singularities.

¹On leave from ITEP, Russia, Moscow, B. Cheremushkinskaya, 25

Contents

1	Introduction	1
2	Deformed $\mathbb{C}^2/\mathbb{Z}_2$	5
3	ISS from the Suspended Pinch Point singularity	7
3.1	D-branes at a deformed SPP singularity	8
3.2	Dynamical SUSY breaking	10
3.3	SUSY restoration	12
4	Type IIA dual of the SPP singularity	17
5	F-term via a Deformed Moduli Space	19
6	Concluding remarks	24
A.	ISS quiver via an RG cascade	26

1 Introduction

Finding robust string realizations of gauge theory models that exhibit dynamical SUSY breaking (DSB) is an important facet of string phenomenology. While recent studies have uncovered a growing number of string systems with DSB, there are only a few examples known in which the SUSY breaking mechanism is well understood from both the gauge theory side and the geometric string perspective.

The dynamical mechanism of SUSY breaking assumes that the lagrangian is supersymmetric but that, due to non-perturbative dynamics, the vacuum configuration breaks SUSY at an exponentially low scale [1]. In general, such non-supersymmetric vacuum states need not be the true vacuum of the theory, but may instead represent long-lived metastable states. While controlled examples of metastable vacua in string theory have been known for some time [2], the increased recent interest in their manifestations and properties was sparked by the discovery by Intriligator, Seiberg, and Shih of a metastable SUSY breaking vacuum for SQCD with $N_f > N_c$ massive flavors [3]. Realizations of the ISS mechanism in string theory, as well as other stringy systems with metastable SUSY breaking, have since been found [4][5][6][7]. Another recent advancement has been to merge the calculational power of geometric transitions with insights from field theory to engineer basic field

theoretic models of SUSY breaking [8].

In this paper, we will consider gauge theories on D-branes near a singularity inside a Calabi-Yau manifold. Our goal is to identify a general geometric criterion for the existence of F-type SUSY breaking, and to use this insight to construct simple examples of D-brane systems that exhibit metastable SUSY breaking. F-type SUSY breaking corresponds to the unsolvability of F-term equations

$$\frac{\partial W}{\partial \Phi} \neq 0 \tag{1}$$

where $W(\Phi)$ is a superpotential depending on the chiral field Φ . The simplest example of this type is the Polonyi model, consisting of a single chiral field with superpotential $W(\Phi) = f\Phi$ in which SUSY is broken by the non zero vacuum energy $V \sim |f|^2$.

We will assume that the non-perturbative dynamics manifests itself in deformations of a theory with unbroken SUSY. The main purpose of our paper is to study the consequences of these deformations. In the context of D-branes in IIB string theory, deformations of the superpotential correspond to complex deformations in the local geometry. The deformed geometry still satisfies the Calabi-Yau condition and the D-brane lagrangian is fully supersymmetric but the vacuum configuration of the gauge theory breaks SUSY spontaneously. In the geometric setting, this corresponds to a D-brane configuration that, while submerged inside a supersymmetric background, gets trapped in a non-supersymmetric ground state.

As a simple illustrative example, consider type IIB string theory on a $\mathbb{C}^2/\mathbb{Z}_2$ orbifold singularity [9][10], with N fractional D5-branes wrapped on the collapsed 2-cycle. The corresponding field theory consists of a $U(N)$ gauge theory with a complex adjoint chiral field Φ . Since the \mathbb{Z}_2 orbifold locus defines a non-isolated singularity inside \mathbb{C}^3 , the fractional D5-branes are free to move along a complex line. The location of the N branes along the non-isolated singularity is parameterized by the N diagonal entries of the complex field Φ . As we discuss in more detail in section 2, there exist a deformation of the singularity that corresponds to adding the F-term

$$W = \zeta \text{Tr}\Phi \tag{2}$$

to the superpotential. Geometrically, the parameter ζ is proportional to the period of the holomorphic two-form over the deformed 2-cycle. The fractional D-brane gauge theory then breaks SUSY in a similar way to the Polonyi model. This simple observation lies at the heart of many type IIB D-brane constructions of gauge theories that exhibit F-term SUSY

breaking.² SUSY breaking via D-terms can be described analogously.³

We wish to use this simple geometric insight to construct more interesting gauge theories with DSB, and in particular, with ISS-type SUSY breaking and restoration. When viewed as a quiver theory, the ISS model has two nodes, a “color” node with gauge group $SU(N)$ and a “flavor” node with $SU(N_f)$ symmetry. The “flavor” node has an adjoint field. This suggests that the flavor node must be represented by a stack of N_f fractional branes on a non-isolated singularity. The “color” node, on the other hand, does not have an adjoint, and thus corresponds to branes that are bound to a fixed location. The natural representation for the color node is via a stack of N branes placed at an isolated singularity.

Our geometric recipe for realizing an ISS model in IIB string theory is as follows:

1. Find a Calabi-Yau geometry with a non-isolated singularity passing through an isolated singularity such that there exists a deformation of the non-isolated singularity.
2. Put some number of D-branes on the isolated singularity and some number of fractional branes on the non-isolated singularity. By conservation of charge, the branes can not leave the non-isolated singularity.
3. When we deform the non-isolated singularity, an F-term gets generated that results in dynamical SUSY breaking. The fractional branes have a non-zero volume, and their tension lifts the vacuum energy above that of the SUSY vacuum.
4. There is a classical modulus corresponding to the motion of the fractional branes along the non-isolated singularity. This modulus can be fixed in a way similar to ISS, by the interaction with the branes at the isolated singularity.

Following this recipe we will geometrically engineer, via an appropriate choice of the geometry and fractional branes, gauge theories that are known to exhibit meta-stable DSB. The eventual goal is to fully explain in geometric terms all field theoretic ingredients: the field content and couplings, the meta-stability of the SUSY-breaking vacuum, and the process of SUSY restoration. While in our examples we will be able identify all these

²F-term SUSY breaking in type IIB D-brane constructions naturally involves deformed non-isolated singularities, that support finite size 2-cycles which D5-branes can wrap [9]. Deformations of isolated singularities correspond to 3-cycles that in type IIB cannot be wrapped by the space-time filling D-branes.

³ Turning on the FI parameters of the type IIB D-brane gauge theory amounts to blowing up the collapsed two-cycles of a CY singularity. These blowup modes are Kähler deformations of the geometry, and are somewhat harder to control in a type IIB setup than the complex structure deformations that we use in our study.

ingredients, we will not have sufficient dynamical control over the D-brane set-up to in fact *proof* the existence of a meta-stable state on the geometric side. Rather, by controlling the geometric engineering dictionary, we can rely on the field theory analysis to demonstrate that the system has the required properties.

This wish to have geometrical control over the field theory parameters also motivates why we prefer to work with local IIB D-brane constructions. Although we will work in a probe approximation, in principle we could extend our analysis to the case where the number of branes becomes large. In this AdS/CFT limit, there should exist a precise dictionary between the couplings in the field theory and the asymptotic boundary conditions on the supergravity fields [11]. By changing these boundary conditions one can tune the UV couplings. This in principle allows full control over the IR couplings and dynamics.

The organization of the paper is as follows. In section 2, as a warm-up, we discuss the F-term deformation of D-branes on $\mathbb{C}^2/\mathbb{Z}_2$. In section 3 we describe the realization of meta-stable supersymmetry breaking via D-branes on the suspended pinch point singularity. We find that supersymmetry restoration involves a geometric transition. In section 4 we give the IIA dual description of the same system and find that it is similar to the IIA constructions of [5, 12]. Finally, in section 5, we present a D-brane realization of the Intriligator-Thomas-Izawa-Yanagida model [14, 15], as an example of a system in which the F-term, that triggers SUSY breaking, is dynamically generated via a quantum deformation of the moduli space.

When this paper was close to completion, an interesting paper [8] appeared in which closely related results were reported.⁴ In agreement with our observations, in [8] the F-term SUSY breaking takes place due to the presence of fractional D5-branes on slightly deformed non-isolated singularities. One of the main points in [8] was to show that the deformation can be computed exactly in the framework of geometric transitions: this is an important step in finding calculable examples of SUSY breaking in string theory. The main point of our paper is to identify simple geometric criteria for the existence of SUSY breaking vacua that can have more direct applications in model building.

⁴The IIB string realizations of DSB found in [8] were motivated by the earlier related work [16] in type IIA theory, and by the idea of retrofitting simple systems with DSB, put forward in [17].

2 Deformed $\mathbb{C}^2/\mathbb{Z}_2$

The $\mathbb{C}^2/\mathbb{Z}_2$ singularity, or A_1 singularity, is described by the following complex equation in \mathbb{C}^3

$$cd = a^2, \quad (a, b, c) \in \mathbb{C}^3. \quad (3)$$

A D3-brane on $\mathbb{C}^2/\mathbb{Z}_2$ has a single image brane. The brane and image brane recombine in two fractional branes. Correspondingly, the quiver gauge theory for N D3-branes at the A_1 singularity has two $U(N)$ gauge groups. It also has two adjoint matter fields Φ_1 and Φ_2 (one for each gauge group), and two pairs of chiral fields A_i and B_j $i, j = 1, 2$ in the bifundamental representations (N, \bar{N}) and (\bar{N}, N) [9][10]. The superpotential reads

$$W = g \text{Tr} \Phi_1 (A_1 B_2 - B_1 A_2) + g \text{Tr} \Phi_2 (A_2 B_1 - B_2 A_1) \quad (4)$$

A D3-brane has 3 transverse complex dimensions. The transverse space $\mathbb{C}^2/\mathbb{Z}_2 \times \mathbb{C}$ has a non-isolated A_1 singularity. It is therefore possible to separate the fractional branes. This corresponds to giving different vevs to the two adjoint fields. In the limit of infinite separation one can consider a theory with only one type of fractional brane. This theory consists of a $U(N)$ gauge field with one adjoint matter field and no fundamental matter.

Let us add an F and a D -term

$$W_F = \zeta \text{Tr}(\Phi_2 - \Phi_1), \quad V_D = \xi \text{Tr}(D_2 - D_1). \quad (5)$$

The resulting F and D-term equations read

$$\begin{aligned} \Phi_1 A_1 - A_1 \Phi_2 = 0, & \quad A_2 \Phi_1 - \Phi_2 A_2 = 0, & \quad A_1 B_2 - B_1 A_2 = \zeta, \\ \Phi_1 B_1 - B_1 \Phi_2 = 0, & \quad B_2 \Phi_1 - \Phi_2 B_2 = 0, & \quad |A_1|^2 + |B_1|^2 - |A_2|^2 - |B_2|^2 = \xi. \end{aligned} \quad (6)$$

These equations allow for a supersymmetric solution, provided we set the adjoint vevs to be equal, $\Phi_1 = \Phi_2$. For generic ζ and ξ , some of the A and B fields acquire vevs and break the $U(N) \times U(N)$ symmetry to a diagonal $U(N)$. This corresponds to joining the $2N$ fractional branes into N D3-branes. The space of solutions of the F and D-term equations is the space where the D3-brane moves, which turns out to be a deformed A_1 singularity described by the equation⁵

$$cd = a(a - \zeta), \quad (7)$$

⁵The general deformations of orbifold singularities of \mathbb{C}^2 were found by Kronheimer [18] as some hyperkahler quotients. Douglas and Moore noticed [9] that these hyperkahler quotients are described by the F and D-term equations for D-branes at the corresponding orbifold singularities.

where $c = A_1 A_2$, $d = B_1 B_2$ and $a = A_1 B_2 = B_1 A_2 + \zeta$ are the gauge invariant combinations of the fields (in the last definition we used the F-term equation for the Φ field).

The F-term coefficient ζ deforms the singularity, the D-term coefficient, or FI parameter, ξ represents a resolution of the \mathbb{Z}_2 singularity. In two complex dimensions both the resolution and the deformation correspond to inserting a two-cycle, $E \sim \mathbb{CP}^1$, instead of the singular point. The parameters ξ and ζ are identified with the periods of the Kahler form and the holomorphic two-form on the blown up 2-cycle E

$$\xi = \int_E J, \quad \zeta = \int_E \Omega^{(2)}. \quad (8)$$

The non-supersymmetric vacuum state arises in the regime where the vevs of the two adjoint fields Φ_1 and Φ_2 are both different. Geometrically, this amounts to separating the two stacks of fractional branes. The bifundamental fields (A_i, B_i) , which arise as the ground states of open strings that stretch between the two fractional branes, then become massive. In the deformed theory, the F-term equations can not be satisfied and SUSY is broken. In the extreme case, where one of the two stacks of fractional branes has been moved off to infinity, so that e.g. $\langle \Phi_2 \rangle \rightarrow \infty$, the system reduces to the Polonyi model: a single $U(N)$ gauge theory with a complex adjoint Φ_1 and superpotential $W = \zeta \text{Tr} \Phi_1$. The vacuum energy $V = N|\zeta|^2$ is interpreted as the tension of the N fractional branes wrapped over the deformed two-cycle.

Strictly speaking the single stack of fractional branes on a deformed singularity is a supersymmetric configuration (one manifestation is that the spectrum of particles in Polonyi model is supersymmetric). In order to break SUSY we really need the second stack of different fractional branes on a large but finite distance. In this case, the SUSY breaking vacuum is not stable due to the attraction between the two stacks of branes.

Before we get to our main example of the SPP singularity, let us make a few comments:

1. The gauge theory on N fractional branes on the $\mathbb{C}^2/\mathbb{Z}_2$ singularity is an $\mathcal{N} = 2$ $U(N)$ theory. If we deform the singularity, then SUSY is broken, whereas in general, $\mathcal{N} = 2$ theories are not assumed to have SUSY breaking vacua (see, e.g., Appendix D of [3]). The point is that the SUSY breaking occurs in the $U(1)$ part of $U(N)$ that decouples from $SU(N)$. Moreover the $\mathcal{N} = 2$ $U(1)$ theory consists of two non-interacting $\mathcal{N} = 1$ theories: a vector boson and a chiral field. Thus the chiral field $\varphi = \text{Tr} \Phi$, responsible for SUSY breaking, is decoupled from the rest of the fields in $\mathcal{N} = 2$ $U(N)$ and SUSY is broken in the same way as in the Polonyi model.

2. In general, we consider $\mathcal{N} = 1$ theories on isolated singularities that intersect non-isolated singularities. With appropriate tuning of the couplings, the fractional branes wrap

ping the non-isolated cycles provide an $\mathcal{N} = 2$ subsector in the $\mathcal{N} = 1$ quiver. Removing the D-branes along the non-isolated singularity reduces the field theory on their world volume to $\mathcal{N} = 2$ SYM. For this reason the fractional branes on the non-isolated singularity can be called $\mathcal{N} = 2$ fractional branes [19][20]. Similarly to $\mathbb{C}^2/\mathbb{Z}_2$ example, the presence of $\mathcal{N} = 2$ fractional branes on slightly deformed non-isolated singularity breaks SUSY.

3. The use of $\mathcal{N} = 2$ fractional branes is the distinguishing property of our construction from SUSY breaking by obstructed geometry [19][21][22]. The presence of the non-isolated singularity enables the relevant RR-fluxes escape to infinity without creating a contradiction with the geometric deformations. In this way one can avoid the generic runaway behavior (see, e.g., [23] [24]) of obstructed geometries (in our case we still need to take the one loop corrections to the potential into account in order to stabilize the flat direction along the non-isolated singularity).

3 ISS from the Suspended Pinch Point singularity

In this section, we will show how to engineer a gauge theory with ISS-type SUSY breaking by placing fractional branes on the suspended pinch point (SPP) singularity. First, however, we summarize the arguments that lead us to consider this particular system.

As we have seen in the previous section, several aspects of the ISS model are quite similar to the $\mathbb{C}^2/\mathbb{Z}_2 = A_1$ quiver theory. The term linear in the adjoint in the ISS superpotential is the ζ deformation of the A_1 singularity. Both models have two gauge groups (the global flavor symmetry $SU(N_f)$ in ISS can be thought of as a weakly coupled gauge symmetry). The flavor gauge group is bigger than the color gauge group – this can be achieved in the A_1 quiver by introducing an excess of fractional branes of one type. The vevs of bifundamental fields break $SU(N_f) \times SU(N) \rightarrow SU(N)_{diag} \times SU(N_f - N)$. The breaking of $SU(N) \times SU(N) \rightarrow SU(N)_{diag}$ corresponds to recombination of N pairs of fractional branes into N (supersymmetric) D3-branes. The vacuum energy is proportional to the tension of the remaining $N_f - N$ fractional branes.

There is however an important difference between the two systems. In ISS it is crucial that the color node $SU(N)$ doesn't have an adjoint field and that all the classical moduli are lifted by one loop corrections. In the $\mathbb{C}^2/\mathbb{Z}_2$ orbifold there is also an adjoint in the “flavor” node. Giving equal vevs to the two adjoints in the $\mathbb{C}^2/\mathbb{Z}_2$ quiver corresponds to the “center of mass” motion of the system of branes along the non-isolated singularity. This mode doesn't receive corrections and remains a flat direction.

Thus, the key distinguishing feature of ISS relative to the $\mathbb{C}^2/\mathbb{Z}_2$ model is that the

color gauge group $SU(N)$ has no adjoints. For constructing a geometric set-up, we need a mechanism that fixes the position of the N D3-branes. The gauge theories without adjoint fields are naturally engineered by placing D-branes on isolated singularities.

Our strategy will be to find an example of a geometry that has a non-isolated A_1 singularity that at some point gets enhanced by an isolated singularity. The fractional branes on the A_1 will provide the $SU(N_f)$ symmetry; they interact with N branes at the isolated singularity, that carry the $SU(N)$ color gauge group. Such systems are easy to engineer. The most basic examples are provided by the generalized conifolds [25], the simplest of which is the suspended pinch point singularity.⁶

A similar mechanism of dynamical SUSY breaking for the SPP singularity was previously considered in [20]: SUSY is broken by the presence of D-branes on the deformed A_1 singularity. The essential difference is that in our case the A_1 singularity is deformed without the conifold transitions within the SPP geometry. In fact, we will show that the conifold transition is responsible for SUSY restoration.

3.1 D-branes at a deformed SPP singularity

The suspended pinch point (SPP) singularity may be obtained via a partial resolution of a $\mathbb{Z}_2 \times \mathbb{Z}_2$ singularity [28]. It is described by the following complex equation in \mathbb{C}^4

$$cd = a^2b, \quad (a, b, c, d) \in \mathbb{C}^4. \quad (9)$$

There is a $\mathbb{C}^2/\mathbb{Z}_2$ singularity along $b \neq 0$. The quiver gauge theory for N D3-branes at the SPP singularity is shown in figure 1. It was derived in [28] by turning on an FI parameter ξ in the $\mathbb{Z}_2 \times \mathbb{Z}_2$ quiver gauge theory, and working out the resulting symmetry breaking pattern. The superpotential of the SPP quiver gauge theory reads

$$W = \text{Tr} \left(\Phi(\tilde{Y}Y - \tilde{X}X) + h(Z\tilde{Z}X\tilde{X} - \tilde{Z}ZY\tilde{Y}) \right) \quad (10)$$

where h is a dimensionful parameter (related to the FI parameter via $h = \xi^{-1/2}$).

As a quick consistency check that this theory corresponds to a stack of D3-branes on the SPP singularity, consider the F-term equations for a single D3-brane. The gauge invariant

⁶ The relevance of generalized conifolds and, in particular, the suspended pinch point was stressed to us by Igor Klebanov. See also [4][26][27] for the earlier constructions of the metastable SUSY breaking vacua in the generalized conifolds.

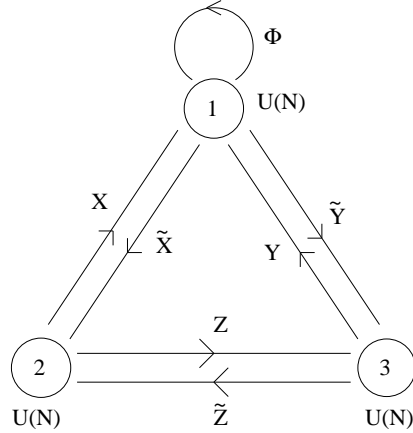

Figure 1: *Quiver gauge theory for N D3-branes at a suspended pinch point singularity.*

combinations of the fields are

$$\begin{aligned}
 a &= \tilde{X}X = \tilde{Y}Y & c &= X\tilde{Y}\tilde{Z} \\
 b &= Z\tilde{Z} & d &= Y\tilde{X}Z
 \end{aligned}
 \tag{11}$$

where we used the F-term equation for Φ . These quantities (a, b, c, d) satisfy the constraint $cd = a^2b$, which is the same as the equation for the SPP singularity.

Following our recipe as outlined in the introduction, we now deform the non-isolated A_1 singularity inside the SPP as follows

$$cd = a(a - \zeta)b. \tag{12}$$

This deformation removes the A_1 singularity, replacing it by a finite size 2-cycle. The deformed SPP geometry has two conifold singularities, located at $a = 0$ and $a = \zeta$, with all other coordinates equal to zero. In the field theory, the above deformation corresponds to adding an F -term of the form

$$W_\zeta = -\zeta \text{Tr}(\Phi - h\tilde{Z}Z). \tag{13}$$

This extra superpotential term is chosen such that the F-term equations for Φ and Z

$$\tilde{X}X - \tilde{Y}Y - \zeta = 0, \quad \tilde{Z}(\tilde{Y}Y - \tilde{X}X + \zeta) = 0, \tag{14}$$

are compatible.

The correspondence between (13) and (12) is easily verified. Again, consider the gauge theory on a single D3-brane. In view of the deformed F-term equation, the quantity a now needs to be defined via

$$a = \tilde{Y}Y = \tilde{X}X + \zeta. \quad (15)$$

The constraint equation thus gets modified to $cd = a(a - \zeta)b$, which is the equation for the deformed SPP singularity.

As we increase ζ , the two conifold singularities at $a = 0$ and $a = \zeta$ become geometrically separated and the D-branes end up on either of the two conifolds. The field theory should thus contain two copies of the conifold quiver gauge theory. To verify this, consider the vacuum $Y = \tilde{Y} = \sqrt{\zeta}I$, which solves both the F-term equations (14) and the D-term equations $|Y|^2 - |\tilde{Y}|^2 = 0$. These vevs break the gauge group $SU(N)_1 \times SU(N)_3$ to $SU(N)_{diag}$ and give a mass to the Higgs-Goldstone field $Y_- = \frac{1}{\sqrt{2}}(Y - \tilde{Y})$. Substituting the remaining fields in the superpotential, one finds that the fields Φ and $Y_+ = \frac{1}{\sqrt{2}}(Y + \tilde{Y})$ are also massive. The surviving massless fields with the superpotential

$$W_{\text{con}} = h(Z\tilde{Z}X\tilde{X} - \tilde{Z}Z\tilde{X}X) \quad (16)$$

reproduce the conifold quiver gauge theory.

In general, both X and Y have vevs and the D-branes split into two stacks $N_1 + N_2 = N$ that live on the two conifolds. Note, that the Z field in (13) corresponds to strings stretching between the two conifolds. The mass of this field is proportional to the length of the string given by the size of the deformed two-cycle.

3.2 Dynamical SUSY breaking

A straightforward way to generate dynamical SUSY breaking is to reproduce the ISS model by placing some fractional branes on the SPP singularity. Suppose that there are $N_f = N + M$ fractional branes corresponding to node 1 in figure 1, N fractional branes corresponding to node 3, and no fractional branes at node 2. The reduced quiver diagram is shown in figure 2. The superpotential for this quiver gauge theory is

$$W = h\zeta \text{Tr}(\Phi) - h \text{Tr}(\Phi Y \tilde{Y}), \quad (17)$$

which is the same as the ISS superpotential in the IR limit [3], with the $SU(N)$ identified as the “color” group and $SU(N + M)$ as the “flavor” symmetry. The only difference between our gauge theory and the ISS system is that the “flavor” symmetry is gauged.

The corresponding gauge coupling is proportional to a certain period of the B-field. We can tune it to be small and treat the gauge group as a global symmetry in the analysis of stability of the vacuum.⁷

An empty node in the quiver introduces some subtleties, since there might be instabilities or flat directions at the last step of duality cascade leading to this empty node. In Appendix A we show that this quiver can be obtained after one Seiberg duality from an SPP quiver without empty nodes.

Recall that in the field theory SUSY is broken since the F-term equations for Φ

$$Y\tilde{Y} = \zeta \mathbb{1}_{N+M} \quad (18)$$

cannot be satisfied by the rank condition. In the vacuum where

$$Y\tilde{Y} = \zeta \mathbb{1}_N, \quad (19)$$

the $SU(N)_1 \times SU(N+M)_3$ gauge symmetry is broken to $SU(N)_{diag} \times SU(M)_3$. The superpotential for the remaining $M \times M$ part of the adjoint field reduces to the Polonyi form

$$W = h\zeta \text{Tr}_M(\Phi). \quad (20)$$

The metastable ground state thus has a vacuum energy proportional to $Mh^2\zeta^2$.

We can interpret the SUSY breaking vacuum on the geometric side as follows. Our system contains N fractional branes that wrap one of the conifolds inside the deformed SPP singularity, and $(N+M)$ fractional branes that wrap the 2-cycle of the deformed A_1 . The $\Phi = 0$ vacuum corresponds to putting all the $(N+M)$ fractional branes on top of the N branes at the conifold (see fig. 2).

The Y modes represent the massless ground states of the open strings that connect the two types of branes. The non-zero expectation value (19) for $Y\tilde{Y}$ corresponds to a condensate of these massless strings between N branes wrapping α_3 and N branes wrapping $\alpha_1 = -\alpha_2 - \alpha_3$. As a result of condensation, these two stacks of N fractional branes recombine into N fractional branes wrapping $-\alpha_2$ at the second conifold. The remaining

⁷ In fact, the restriction on the coupling is not very strong, because the SUSY breaking field $\text{Tr}\Phi$ couples only to the bifundamental fields Y, \tilde{Y} through the superpotential (17) (see also figure 2). Since the stabilization of the SUSY vacuum comes from the masses of these bifundamental fields it is sufficient to require that the corrections to the masses due to the gauge interactions are small at the SUSY breaking scale.

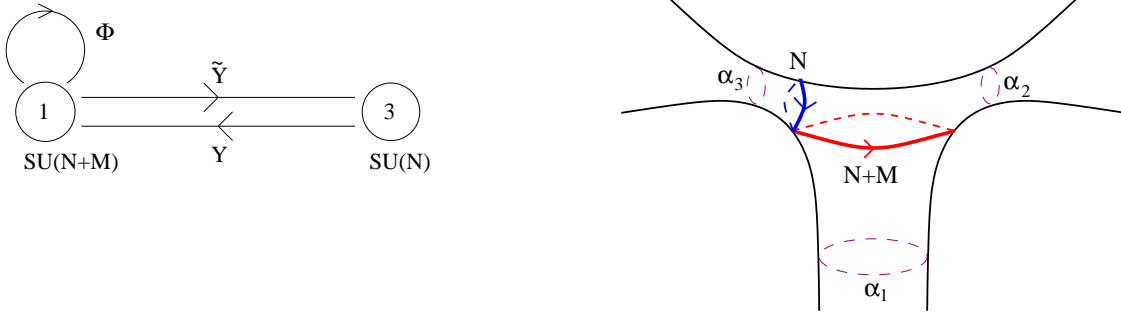

Figure 2: A particular combination of fractional branes on the SPP singularity and the corresponding quiver gauge theory that reproduce the ISS model. The cycle α_1 is a non-isolated two-cycle of the deformed A_1 singularity inside the SPP. The cycles α_2 and α_3 denote the isolated two-cycles on the two conifolds that remain after the deformation of the A_1 singularity. The cycles satisfy $\alpha_1 + \alpha_2 + \alpha_3 = 0$. The N fractional branes wrapping α_3 are supersymmetric. The $N + M$ fractional branes wrapping α_1 break SUSY. This combination of fractional branes corresponds to zero vevs of the bifundamental fields in the ISS.

M fractional branes around the deformed A_1 end up in a non-supersymmetric state. The diagonal entries of the $M \times M$ block in Φ parameterize the motion of the M branes along the deformed non-isolated singularity. The corresponding configuration of branes is represented in figure 3.

The stability of the SUSY breaking vacuum is a quantum effect in the field theory—there are pseudo-moduli that acquire a stabilizing potential at one loop [3]. In the D-brane picture this should correspond to the back reaction of the branes that makes the two-cycle at the deformed A_1 singularity grow as one moves away from the conifold. (Alternatively one can think about a weak attraction between the branes.) It would be interesting to derive this directly from SUGRA equations, since it would complete the geometric evidence for the existence of the SUSY breaking vacuum.

3.3 SUSY restoration

Let us discuss SUSY restoration in this setup. The SUSY vacuum is found by separating the $(N + M)$ fractional branes on the deformed $\mathbb{C}^2/\mathbb{Z}_2$ singularity from the N fractional branes at the conifold. This separation amounts to giving a vev to Φ . Initially this costs energy. The fields Y and \tilde{Y} become massive. Below their mass scale, the theory on the N

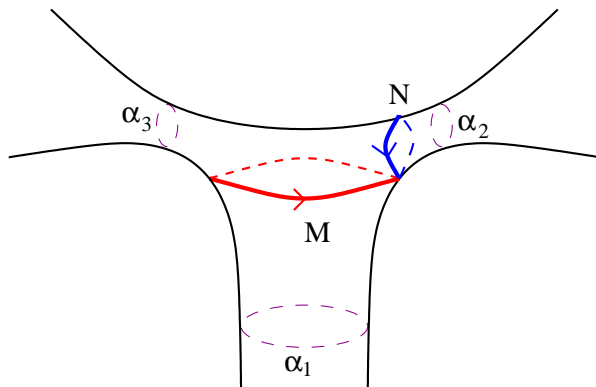

Figure 3: *In the metastable vacuum. N supersymmetric fractional branes wrap the $-\alpha_2$ cycle of the second conifold. The remaining M fractional branes wrap the non-isolated cycle $\alpha_1 = -\alpha_2 - \alpha_3$ and are weakly bound to the N branes at the conifold. This configuration of fractional branes is obtained from the configuration in figure 2 by giving vevs to the bifundamental fields.*

fractional branes at the conifold becomes strongly coupled and develops a gaugino condensate. This condensate deforms the conifold singularity, and generates an extra term in the superpotential for Φ that eventually restores SUSY.

On the gauge theory side, the SUSY restoring superpotential term arises due to the fact that the value of the gaugino condensate depends on the masses of Y and \tilde{Y} , and these in turn depend on the vev of Φ . As a result [3], the gaugino condensation modifies the superpotential for Φ to (here $N_f = N + M$)

$$W_{low} = N \left(h^{N_f} \Lambda_m^{-(N_f - 3N)} \det \Phi \right)^{1/N} - h\zeta \text{Tr} \Phi. \quad (21)$$

Due to the extra term, the F-term equations

$$\frac{\partial W_{low}}{\partial \Phi} = 0 \quad (22)$$

can be solved. In fact there are $N_f - N = M$ SUSY vacua $\Phi = \Phi_k$, with $k = 1, \dots, M$.

On the geometric side, the SUSY vacuum is interpreted as the ground state of $N + M$ fractional branes in the presence of a deformed conifold singularity. Suppose that the deformed conifold is the one located at $a = \zeta$. One can describe the situation after the geometric transition by the following equation

$$cd = a((a - \zeta)b + \epsilon). \quad (23)$$

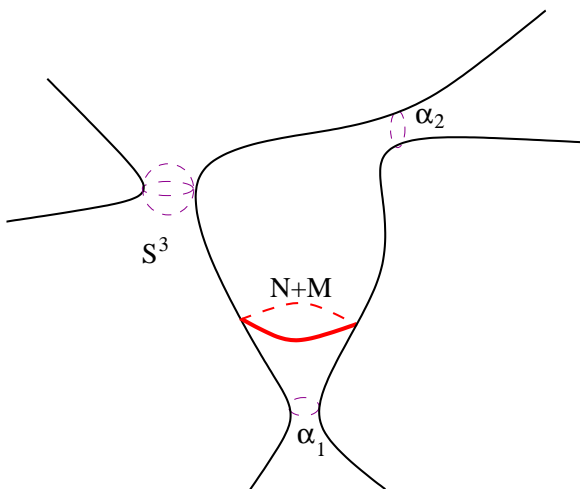

Figure 4: *To reach the supersymmetric ground state, the $N + M$ fractional branes on the A_1 2-cycle move away from the conifold. The N fractional branes on the conifold then drive the geometric transition: the two-cycle α_3 is replaced by the three sphere S^3 . After the transition, the size of the A_1 2-cycle reaches a zero minimum at a new conifold singularity (indicated by the position of α_1).*

The original conifold singularity at $a = \zeta$ is now a smooth point in the geometry. However, a new singularity has appeared in the form of an undeformed conifold at $a = c = d = 0$ and $b = \epsilon/\zeta$. The D5-branes that were originally stretching between $a = 0$ and $a = \zeta$ can thus collapse to a supersymmetric state by wrapping the zero-size 2-cycle of the undeformed conifold. This process is the geometric manifestation of SUSY restoration in the underlying ISS gauge theory.⁸

Using the geometric dual description, it is possible to rederive the field theory superpotential (21) and even compute higher-order corrections. The calculation goes as follows, [8]. Let us rewrite the geometry (23) as:

$$uv = (z - x)((z + x)(z - x - \zeta) + \epsilon), \quad (24)$$

⁸A similar mechanism of SUSY restoration in the case of SPP singularity was anticipated in [19]

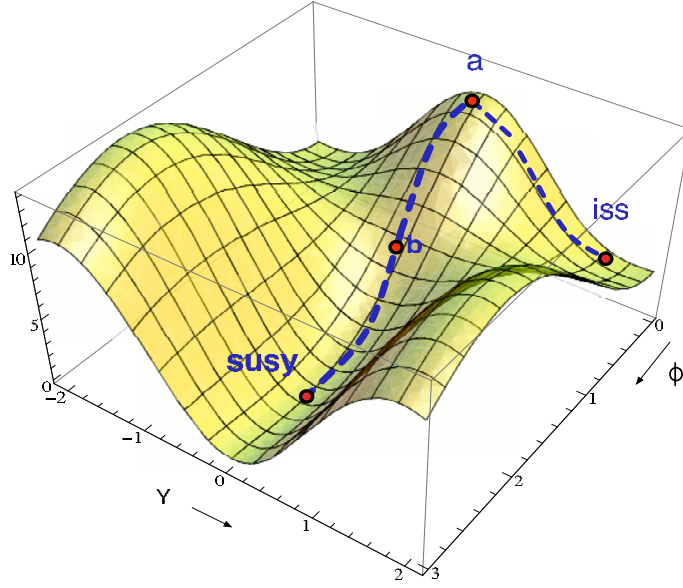

Figure 5: *The gauge theory potential as a function of the vevs of the adjoint Φ and bifundamental Y . Suppose we start at point **a** corresponding to the situation in fig. 2 with the zero vevs of Φ and $Y\tilde{Y}$. This point is unstable and there are two possibilities. If the bifundamental fields $Y\tilde{Y}$ get a vev, then we end up in the metastable ISS vacuum in fig. 3. If the adjoint field Φ gets a vev, then we follow the path to the SUSY vacuum (an intermediate point on the SUSY restoring path is shown in fig. 4).*

where $z - x = a$, $z + x = b$. Also it is useful to introduce the following notation

$$\begin{aligned}
 z_1(x) &= x & \tilde{z}_2(x) &= \zeta/2 - \sqrt{(x + \zeta/2)^2 - \epsilon} \\
 z_2(x) &= -x & \tilde{z}_3(x) &= \zeta/2 + \sqrt{(x + \zeta/2)^2 - \epsilon} \\
 z_3(x) &= x + \zeta
 \end{aligned} \tag{25}$$

The conifold singularity is at $z = x = \epsilon/2\zeta \equiv x_*$. If initially the fractional D-branes on the deformed A_1 were stretching between $z_1(x)$ and $z_3(x)$, then after the geometric transition, they stretch between $z_1(x)$ and $\tilde{z}_3(x)$. They can minimize their energy by moving (or tunneling) to the conifold singularity at $z = z_1(x_*) = \tilde{z}_3(x_*)$.

For the geometric derivation of the superpotential, we take the deformation parameter ϵ to be dynamical, and related to the gaugino condensate via $\epsilon = 2S$.⁹ We also identify Φ with the location x of the D5-branes relative to the (deformed) conifold at $a = \zeta$. The

⁹The constant 2 appears due to the consistency conditions between the geometric derivation of the superpotential and the KS superpotential for the conifold.

superpotential for the gaugino condensate together with the adjoint field is [8]

$$W(S, \Phi) = NS \left(\log \frac{S}{\Lambda^3} - 1 \right) + \frac{t}{g_s} S + \tilde{W}(\Phi, S). \quad (26)$$

The first two terms comprise the familiar GVW superpotential [29] $W = \int \Omega \wedge G_3$ evaluated for the deformed conifold supported by N units of RR 3-form flux [30][31]. The last term $\tilde{W}(\Phi, S)$ has a closely related, and equally beautiful, geometric characterization in terms of the integral of holomorphic 3-form

$$\tilde{W}(\Phi, S) = \int_{\Gamma} \Omega \quad (27)$$

over a three chain Γ bounded by the 2-cycle wrapped by the D5 brane.¹⁰ Following [8], we can reduce the integral (27) for our geometry (24) to an indefinite 1-d integral

$$\tilde{W}(x) = \int (\tilde{z}_3(x) - z_1(x)) dx \quad (28)$$

with $z_1(x)$ and $\tilde{z}_3(x)$ given in (25).

Let us show that the geometric expression (28) reproduces the gauge theory superpotential. In the appropriate limit, $x \gg \epsilon, \zeta$, we find from (28)

$$\tilde{W}(S, \Phi) = \zeta \text{Tr} \Phi - S \log(\Phi/\Lambda_m). \quad (29)$$

Here we identify (x, ϵ) with $(\Phi, 2S)$, and use the integration constant to introduce a scale Λ_m . Physically, Λ_m sets the scale of the Landau pole for the IR free theory with $3N < N_f$. Minimizing (26) with respect to S we find

$$S = (\Lambda_m^3 \det(\Phi/\Lambda_m))^{1/N} \quad (30)$$

If we substitute S back in (26), we get exactly (21) (up to an overall sign and after the redefinition $\Phi \rightarrow h\Phi$). By expanding the full geometric expression (28) to higher orders, one can similarly extract the multi-instanton corrections to the superpotential.

¹⁰This contribution to the superpotential is easily understood from the perspective of the GVW superpotential. The D5-brane is an electric source for the RR 6-form potential C_6 , and a magnetic source for the RR 3-form field strength $F_3 = dC_2$. If the D5 would traverse some 3-cycle A , this process will induce a jump by one unit in the F_3 -flux through the 3-cycle B dual to A , and thereby a corresponding jump in the GVW superpotential. Continuity of the overall superpotential during this process dictates that the D5-brane contribution must take the form (27).

Our system in fact has other supersymmetric vacua besides the one just exhibited. These arise because, unlike the ISS-system, the flavor symmetry is gauged. If we move M fractional branes away from the conifold singularity in figure 3, then the N fractional branes wrapping the conifold 2-cycle α_2 may also induce a geometric transition. As in the above discussion, this transition also restores SUSY. For a suitable choice of couplings, the extra SUSY vacuum lies farther away than the one considered above. The ISS regime arises when the coupling of the initial “color” $SU(N)$ gauge group is sufficiently bigger than the coupling of the gauged “flavor” group $SU(N+M)$, $g_3 \gg g_1$. (Note that after the symmetry breaking, the coupling of $SU(N)_{diag} \subset SU(N) \times SU(N+M)$ is of order g_1 .) In this section we assumed that we are in this ISS regime.

4 Type IIA dual of the SPP singularity

In this section we present the type IIA dual of our discussion of D-branes at the SPP singularity. In particular, we study the F-term deformations in the corresponding system of NS-branes and D-branes and prove that the IIA dual of the SPP singularity is equivalent to the known IIA representations of ISS [5, 12, 13].

D-branes at singularities of CY manifolds in IIB are T-dual to D-branes stretching between NS-branes in type IIA [32][33]. Consider N D3-branes at the SPP singularity described by the following equation in \mathbb{C}^4

$$uv = x^2z. \tag{31}$$

The resulting space has 6 real dimensions (x_4, \dots, x_9) . Denote $x = x_4 + ix_5$ and $z = x_8 + ix_9$. For $v \neq 0$ one can solve equation (31) for u . Let $v = re^{i\varphi}$ and denote $x_6 = \varphi$, $x_7 = r$. After T-duality in the compact dimension x_6 , we get the configuration of NS branes (blue) and D4-branes (green) in type IIA (this configuration is depicted in figure 6 on the left).

The zeros of polynomials on the right hand side of (31) represent the intersection of NS-branes with the circle in x_6 . There is one NS brane at $z = 0$ and two NS' branes at $x = 0$ (we use the prime to distinguish the two NS branes at $x = 0$ from the NS brane at $z = 0$). The NS branes span the following dimensions

$$NS \quad (0 \ 1 \ 2 \ 3 \ 4 \ 5) \tag{32}$$

$$NS' \quad (0 \ 1 \ 2 \ 3 \ 8 \ 9) \tag{33}$$

The D4-brane between the two NS' branes can freely move in the z direction. This corresponds to the motion of the fractional D3-branes along the line of Z_2 singularities in the z

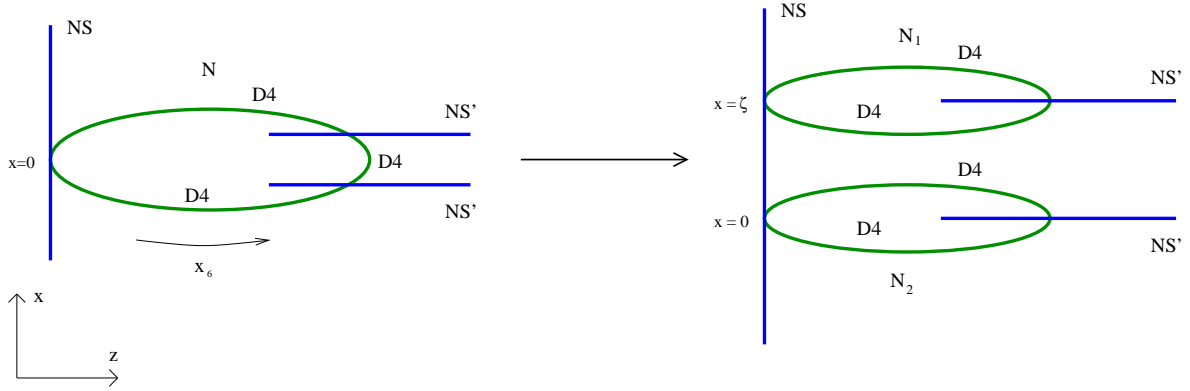

Figure 6: *On the left there are N $D4$ -branes on the “SPP singularity”. After the addition of the F -term ζ , the SPP singularity is transformed to two conifolds at $x = 0$ and $x = \zeta$. The N $D4$ -branes split into $N_1 + N_2 = N$ $D4$ -branes at the two conifolds. (The $D4$ -branes are green and the NS branes are blue.)*

direction of (31). The length of the $D4$ brane in x^6 is mapped, via T-duality, to the period of the B-field on the corresponding shrunken \mathbb{P}^1 :

$$\Delta x^6 = \int_{\mathbb{P}^1} B \sim \frac{4\pi}{g^2} \quad (34)$$

The corresponding field theory is the same as the type IIB quiver gauge theory (10). As we have shown earlier the F -term deformation (13) corresponds to the deformation of the Z_2 singularity in the SPP

$$uv = x(x - \zeta)z \quad (35)$$

In the IIA dual picture this corresponds to moving one of the NS' branes from $x = 0$ to $x = \zeta$. This theory has two conifold points: at $x = 0$ and at $x = \zeta$. The corresponding configuration of branes is shown in figure 6 on the right.

To get the ISS vacuum we take N_f $D4$ -branes between the two NS' branes and N $D4$ -branes between NS'_2 and NS such that $N_f > N$. The corresponding superpotential is

$$W = \text{Tr}(\zeta\Phi - \Phi\varphi\tilde{\varphi}) \quad (36)$$

The F -term equations for the Φ fields are

$$\varphi\tilde{\varphi} = \zeta I_{N_f \times N_f}. \quad (37)$$

The fields φ and $\tilde{\varphi}$ acquire vevs and break the gauge group as $SU(N_f) \times SU(N) \longrightarrow SU(N)_{diag} \times SU(N_f - N)$. This corresponds to recombination of the $D4$ -branes shown in

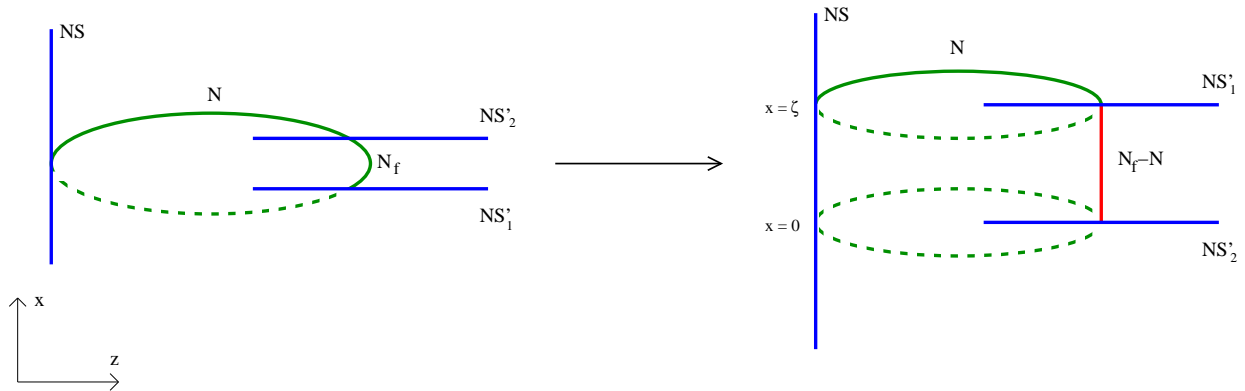

Figure 7: *On the left there are N_f D4-branes stretching between NS'_1 and NS'_2 and N D4-branes stretching between NS'_2 and NS . After turning on the F-term, ζ , there are N supersymmetric D4-branes (green) stretching between NS'_1 and NS and $(N_f - N)$ D4-branes (red) that have non zero size in the x direction and violate the SUSY. The dashed lines represent the empty cycles in the geometry (empty nodes in the corresponding quivers).*

figure 7. The SUSY breaking is due to the $(N_f - N)$ D4-branes stretching a finite distance between $x = 0$ and $x = \zeta$: the tension of these branes creates the vacuum energy. We note, that this configuration of NS-branes and D4-branes is closely related to the constructions of [13] where the $SU(N_f)$ symmetry is slightly gauged compared to the earlier constructions [5, 12] where the $SU(N_f)$ is a flavor symmetry.

5 F-term via a Deformed Moduli Space

In the previous sections we introduced the F-terms by hand, assuming that they are generated somewhere else in the geometry and are not affected by the local field theory (see, e.g., the constructions in [8]). In this section we consider an example of F-term generation in the local field theory by a quantum modified moduli space analogous to the Intriligator-Thomas-Izawa-Yanagida model [14, 15]. Our setup is related to the M-theory example considered in [34].

In order to obtain an ITIY-like model we consider the deformed A_3 singularity in IIB string theory:

$$uv = x^2 z^2. \quad (38)$$

Recall that the $C^2/Z_4 = A_3$ singularity has the equation $uv = x^4$ in \mathbb{C}^3 . The corresponding quiver gauge theory [9] for N D3-branes at the A_3 singularity has four $U(N)$ gauge groups,

four $\mathcal{N} = 2$ hypermultiplets in bifundamental representations of the gauge groups, and four adjoint fields.

The deformation (38) corresponds to giving the masses to two adjoint fields on opposite nodes of the C^2/Z_4 quiver. A general derivation of the correspondence between the geometric deformations and the superpotential for the adjoint fields can be found in [35]. Intuitively, an adjoint field gets a mass if the corresponding fractional brane wraps a collapsed two-cycle that has a non-zero volume away from $x = z = 0$. After integrating out the massive adjoint fields, the remaining fields are the four $U(N)$ gauge groups with bifundamental matter between them and two adjoint fields corresponding to the non-isolated Z_2 singularities at $u = v = x = 0$ and $u = v = z = 0$.

Next, let us add an O3 plane located at $u = v = x = z = 0$. We take the action of the O3 plane to be the same as in [36]:

$$u \rightarrow v, \quad v \rightarrow u, \quad x \rightarrow -x, \quad z \rightarrow -z \quad (39)$$

The $U(N)$ gauge groups become $SO(2N + 2)$ and $Sp(N)$.

To generate the ITIY model, we occupy two out of the four nodes in the quiver. The corresponding quiver gauge theory is shown in figure 8. The N fractional branes corresponding to node 1 give rise to an $Sp(N)$ gauge theory with dynamical scale Λ , while the $N + 1$ fractional branes corresponding to node 2 realize an $SO(2N + 2)$ theory with dynamical scale Λ' . In our example, the beta function for the $Sp(N)$ gauge group is bigger than for $SO(2N + 2)$, i.e. the $Sp(N)$ gauge group confines first. We assume that $\Lambda \gg \Lambda'$ and treat the weakly coupled $SO(2N + 2)$ symmetry as global.

The tree-level superpotential is inherited from the C^2/Z_4 cubic superpotential

$$W = h\Phi_{ij}Q^iQ^j \quad (40)$$

where Φ is an adjoint of $SO(2N + 2)$ and the quarks, Q , transform as bifundamentals of $Sp(N) \times SO(2N + 2)$.

Denote the mesons of the $Sp(N)$ gauge group by $M^{ij} = Q^iQ^j$. After the confinement of $Sp(N)$, the theory has a quantum-deformed moduli space of vacua

$$\text{Pf}M = \Lambda^{2N+2} \quad (41)$$

The superpotential (40) then becomes

$$\tilde{W} = h\Phi M + \lambda(\text{Pf}M - \Lambda^{2N+2}). \quad (42)$$

where λ is the Lagrange multiplier imposing the constraint (41).

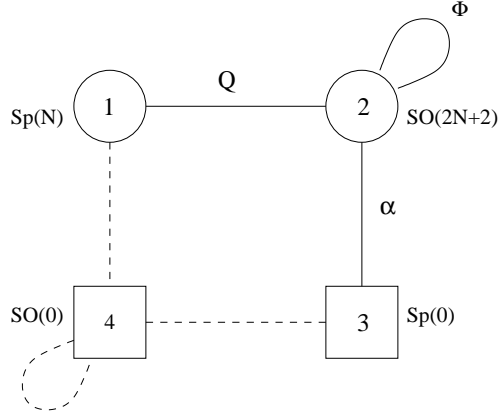

Figure 8: *Quiver gauge theory that reproduces the ITIY model. It is obtained by putting some fractional branes on an orientifold of the deformed A_3 singularity. The circles represent the occupied nodes, while the squares correspond to the empty nodes in the quiver. The field Q is in the bifundamental representation of $Sp(N) \times SO(2N + 2)$. α denotes fermionic zero modes of the D -instantons wrapping the $Sp(0)$ node.*

SUSY is broken since the F-term equations for the Φ field cannot be satisfied. Indeed, the deformed moduli space guarantees that

$$-F_{\Phi}^{\dagger} = M \sim \Lambda^2 \neq 0. \quad (43)$$

Note that we needed to introduce the O3 plane in order to (dynamically) break SUSY since otherwise we would have to take baryonic directions B, \tilde{B} into account in (41). In the absence of competing effects, the baryons are tachyonic and so our potential would take us to zero vev for M , thus allowing the system to relax to a SUSY groundstate.

In order to get a geometric interpretation of the SUSY breaking, let us solve the F-term equations for the λ and M fields

$$\begin{aligned} \text{Pf}M - \Lambda^{2N+2} &= 0; \\ h\Phi_{ij} + \lambda \text{Pf}M \cdot M_{ij}^{-1} &= 0. \end{aligned} \quad (44)$$

Then, the superpotential for Φ reads

$$\tilde{W} = 2h\Lambda^2(N + 1)(\text{Pf}\Phi)^{\frac{1}{N+1}}. \quad (45)$$

Any Φ can be obtained by an $SO(2N + 2)$ rotation from a given element Φ_0 , $\Phi = O\Phi_0O^T$, where we take

$$\Phi_0 = \begin{pmatrix} 0 & R \\ -R & 0 \end{pmatrix} \quad (46)$$

with

$$R = \text{diag}(r_1, \dots, r_{N+1}) \quad (47)$$

The anti-symmetric form of Φ is due to the orientifold projection. Now, plugging (46) into (45) and extremizing the resulting potential, we see that

$$V = 4h^2\Lambda^4 \left(\sum_i \frac{1}{|r_i|^2} \right) \prod_j |r_j|^{\frac{2}{N+1}} \geq 4h^2\Lambda^4(N+1) \quad (48)$$

with the inequality saturated for $r_1 = \dots = r_{N+1}$, i.e.

$$\Phi_0 = r \begin{pmatrix} 0 & \mathbf{1}_{N+1} \\ -\mathbf{1}_{N+1} & 0 \end{pmatrix}. \quad (49)$$

Then $\text{Pf}\Phi = r^{N+1}$ and

$$\tilde{W} = 2h\Lambda^2(N+1)r. \quad (50)$$

In other words, this is a Polonyi model in the flat r direction with a set of Goldstone bosons parameterizing the space of broken symmetries $SO(2N+2)/U(N+1)$. In fact, these goldstone bosons will get eaten at the scale Λ since

$$M = \Lambda^2 \begin{pmatrix} 0 & \mathbf{1}_{N+1} \\ -\mathbf{1}_{N+1} & 0 \end{pmatrix}. \quad (51)$$

as a consequence of satisfying the F-term equations in (44) (this holds for $\forall r \neq 0$ and therefore holds in the limit $r \rightarrow 0$).

Now, by construction, r is uncharged under the $U(N+1)$ group of remaining symmetries. Hence, in particular, we can treat r as a center of mass coordinate of the D-brane system. Then, in analogy with the previous sections, we interpret this superpotential as coming from the complex deformation of the singularity

$$uv = (z - h\Lambda^2)(z + h\Lambda^2)x^2 \quad (52)$$

Here we take the deformation to be invariant under the O-plane action. In the case of the ITIY model, this geometric interpretation has an important limitation. In the previous constructions we assumed that the deformation parameter ζ is a vev of some field that has a mass much bigger than the scale of ζ , i.e. that we can decouple its dynamics from the D-brane dynamics. For the ITIY, the mass of the M fields is proportional to Λ , i.e. the dynamics of M start to play a role already at the SUSY breaking scale. In other words, the geometric formula (52) should be trusted only for $x, z, u, v \ll h\Lambda^2$.

Let us now show that SUSY is restored in this model by contributions from the D-instantons wrapping the empty nodes in quiver 8. The presence of empty nodes seems rather generic in constructions of the ITIY model from D-branes at singularities. The presence of the O3-plane then allows non trivial D-instanton contributions to the superpotential.¹¹ In the case of the $Sp(0)$ node, the ‘+’ orientifold projection lifts the additional zero modes of the D-instanton and allows it to contribute to the superpotential [37, 38, 39] (the corresponding D-instanton zero modes are represented by α in figure 8), while the ‘-’ sign of the projection on the $SO(0)$ node does not lift the extra zero modes and so no contribution to the superpotential is expected from that node.

Integrating out the fermionic zero modes, α_i , resulting from a Euclidean D1 brane wrapping node 3 gives rise to an exponentially suppressed deformation of the superpotential:

$$W = h\Phi M + \epsilon \text{Pf}\Phi \quad (53)$$

where the suppression factor is given by:

$$\epsilon \sim e^{-t/g_s} \quad (54)$$

with t the period of $B^{\text{NS}} + ig_s B^{\text{RR}}$ on the corresponding shrunken 2-cycle. Note that since Φ has $Sp(N)$ non-anomalous R-charge +2, the second term in (53) breaks the R-symmetry and SUSY will be restored for Φ that satisfies:

$$\Phi \sim \frac{\Lambda^{2+2/N}}{h\epsilon^{1/N}} M^{-1} \sim \left(\frac{\Lambda^2}{h^N \epsilon} \right)^{\frac{1}{N}} \quad (55)$$

Since ϵ is parametrically small, we can take it such that the model is rendered metastable. For Φ near the origin, however, the stringy instanton contribution will be dominated by the F-term induced by the $Sp(N)$ quantum deformed moduli space. Based on the form of the D-instanton contribution, we are tempted to identify this term with a geometrical transition in (52). Formally, we can do this and maintain compatibility with the orientifold projection in the limit in which $\Lambda \rightarrow 0$ (this reflects the fact that SUSY restoration occurs in an entirely different regime of field space $\Phi \gg \Lambda$):

$$uv = xz(xz - s) \quad (56)$$

The stability of the SUSY breaking vacuum can be analyzed similarly to [40]. The field r introduced in (49) is a pseudo-modulus. This pseudo-modulus is lifted upward by

¹¹Additional non-perturbative effects in the $U(N+1) \subset SO(2N+2)$ theory are small provided we take Λ' sufficiently small.

corrections to the potential leaving a metastable SUSY-breaking vacuum at the origin, $\Phi = 0$.

One might be worried that contributions from the gauge fields could destabilize the vacuum. The first thing to note is that the r field is not charged under the subgroup $U(N + 1) \subset SO(2N + 2)$ unbroken below Λ . The contributions to the potential from the broken $SO(2N + 2)/U(N + 1)$ gauge sector can be neglected if the corresponding coupling is smaller than the coupling of the matter fields, $g \ll h$, which can be arranged via an appropriate geometric tuning.¹²

6 Concluding remarks

In this paper we presented a simple geometric criterion for the existence of a meta-stable F-term SUSY breaking vacuum in world-volume gauge theories on D-branes. We showed that the basic ingredients of the ISS theory can be realized by placing fractional D-branes on a slightly deformed non-isolated singularity passing through an isolated singularity. We characterized both the meta-stable non-SUSY and stable SUSY vacuum states.

A gap in our study, and an important direction to be explored, is the detailed supergravity analysis of the SUSY breaking vacuum. On the field theory side, the one-loop corrections to the potential are crucial for lifting the classical degeneracy and stabilizing the meta-stable vacuum. In the D-brane picture this corresponds to a weak attraction between the N D-branes at the isolated singularity and the M D-branes at the non-isolated A_1 singularity. This attraction presumably arises due to some back reaction that slightly deforms the 2-cycle of the A_1 singularity, such that its area is minimized near the isolated singularity.

Our construction may be used to introduce SUSY breaking in phenomenological models involving D-branes at singularities of CY manifolds. For example, take the construction of an SM-like theory in terms of D-branes on a del Pezzo 8 singularity considered in [41]. As argued in [41], the symmetry breaking towards the SM requires the formation of an A_2 singularity on the del Pezzo 8 surface. This A_2 lifts to a non-isolated singularity on the cone over del Pezzo. The results in this paper suggest that, if we slightly deform this non-isolated singularity and put a suitable collection of fractional branes on it, we can engineer a SUSY

¹² The couplings of the gauge fields can be tuned by changing the periods of the B -field. If we had an accidental $\mathcal{N} = 2$ supersymmetry, then the couplings g and h would be related, but in our $\mathcal{N} = 1$ setup they are not protected against independent changes.

breaking hidden sector, with charged matter that interacts with the SM part of the quiver. In this way we may be able to build a semi-realistic phenomenological model.

Acknowledgments.

The authors are thankful to Sebastian Franco, Shamit Kachru, Igor Klebanov, David Kutasov, Christopher Herzog, Diego Rodríguez-Gómez, Nathan Seiberg, Eva Silverstein, and Martijn Wijnholt for valuable discussions. This work is supported by the Russian Foundation of Basic Research under grant RFBR 06-02-17383 (DM), an NSF Graduate Research Fellowship (MB), and by the National Science Foundation under grant PHY-0243680. Any opinions, findings, and conclusions or recommendations expressed in this material are those of the authors and do not necessarily reflect the views of the National Science Foundation.

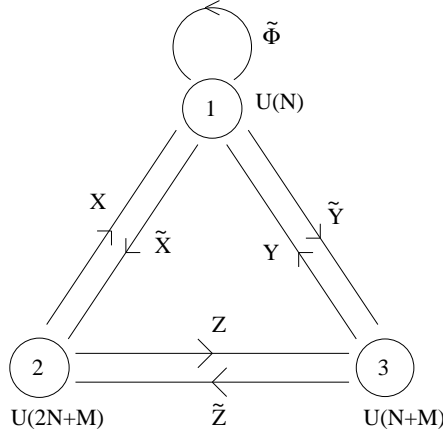

Figure 9: *Quiver gauge theory of the fractional brane configuration on the SPP singularity that reduces to ISS model after confinement of the $SU(2N + M)$ gauge group at node 2.*

A. ISS quiver via an RG cascade

In this appendix we show that the ISS quiver in figure 2 can be obtained after one Seiberg duality from an SPP quiver in figure 9.

This quiver is obtained from the quiver in figure 1 by adding M fractional branes to node 3, and $N + M$ fractional branes to node 2, so that the respective ranks of the gauge groups become $N + M$ and $2N + M$. Note, that this theory has an infinite duality cascade that increases the ranks of the gauge groups, i.e. we can suppose that we start in the UV with some big ranks of the gauge groups and after a number of duality steps arrive at quiver 9. Let us show that after one more duality at node 2 we reproduce the ISS model.

The theory has gauge group $U(N) \times U(2N + M) \times U(N + M)$, one adjoint under $U(N)$ and three vector-like pairs of bi-fundamentals. The superpotential is given by the sum of (10) and (13)

$$W = \text{Tr} \left(-\zeta \tilde{\Phi} + \tilde{\Phi} (\tilde{Y}Y - \tilde{X}X) + h(Z\tilde{Z}X\tilde{X} - \tilde{Z}ZY\tilde{Y} + \zeta \tilde{Z}Z) \right). \quad (57)$$

The $SU(2N + M)$ gauge group confines first. This gauge group has $N_f = N_c$ and thus the gauge group after the Seiberg duality is $U(N) \times U(N + M)$. The two $U(1)$ factors can be represented as the overall $U(1)$ (that decouples) and the non-anomalous $U(1)_B$ gauge group. Denote the meson fields as $M_{xx} = \tilde{X}X$, $M_{xz} = \tilde{X}Z$, $M_{zx} = \tilde{Z}X$, and $M_{zz} = \tilde{Z}Z$. In

addition there are two baryons A and B . After the Seiberg duality, the superpotential is

$$\begin{aligned} \tilde{W} &= \text{Tr} \left(-\zeta \tilde{\Phi} + \tilde{\Phi}(\tilde{Y}Y - M_{xx}) + h(M_{xz}M_{zx} - M_{zz}Y\tilde{Y} + \zeta M_{zz}) \right) \\ &+ \lambda \left(\det \begin{pmatrix} M_{xx} & M_{xz} \\ M_{zx} & M_{zz} \end{pmatrix} - AB - \Lambda^{4N+2M} \right) \end{aligned} \quad (58)$$

Here λ is a lagrange multiplier field. Its constraint equation is the quantum deformed relation between the baryon and meson fields, and dictates that either the baryons or mesons acquire a non-zero vev. We assume that we are on the baryonic branch

$$AB = -\Lambda^{4N+2M}. \quad (59)$$

The vevs of the baryons break the non-anomalous $U(1)_B$. The D-term equations for $U(1)_B$ fix $|A|^2 = |B|^2$.

The adjoint field $\tilde{\Phi}$, and the meson fields M_{xx} , M_{xz} , and M_{zx} are all massive. So we can integrate them out. The reduced gauge theory has gauge group $SU(N) \times SU(N+M)$, a pair of bi-fundamental fields (Y, \tilde{Y}) , and a meson field

$$\Phi = M_{zz} \quad (60)$$

that transforms as an adjoint under $SU(N+M)$. After integrating out the massive fields, the superpotential (58) reduces to the ISS superpotential in the magnetic regime [3]

$$\tilde{W} = h\zeta \text{Tr}(\Phi) - h \text{Tr}(\Phi Y \tilde{Y}), \quad (61)$$

Up to relabeling the nodes 1 and 3, this quiver gauge theory coincides with the quiver in figure 2.

References

- [1] I. Affleck, M. Dine and N. Seiberg, “Dynamical Supersymmetry Breaking In Four-Dimensions And Its Phenomenological Implications,” Nucl. Phys. B **256**, 557 (1985). E. Poppitz and S. P. Trivedi, “Dynamical supersymmetry breaking,” Ann. Rev. Nucl. Part. Sci. **48**, 307 (1998) [arXiv:hep-th/9803107]. K. Intriligator and N. Seiberg, “Lectures on Supersymmetry Breaking,” arXiv:hep-ph/0702069. M. A. Luty, “2004 TASI lectures on supersymmetry breaking,” arXiv:hep-th/0509029.
- [2] S. Kachru, J. Pearson and H. L. Verlinde, “Brane/flux annihilation and the string dual of a non-supersymmetric field theory,” JHEP **0206**, 021 (2002) [arXiv:hep-th/0112197].
- [3] K. Intriligator, N. Seiberg and D. Shih, “Dynamical SUSY breaking in meta-stable vacua,” JHEP **0604**, 021 (2006) [arXiv:hep-th/0602239].
- [4] R. Argurio, M. Bertolini, S. Franco and S. Kachru, “Metastable vacua and D-branes at the conifold,” JHEP **0706**, 017 (2007) [arXiv:hep-th/0703236]. R. Argurio, M. Bertolini, S. Franco and S. Kachru, “Gauge/gravity duality and meta-stable dynamical supersymmetry breaking,” JHEP **0701**, 083 (2007) [arXiv:hep-th/0610212]. [5]
- [5] H. Ooguri and Y. Ookouchi, “Meta-stable supersymmetry breaking vacua on intersecting branes,” Phys. Lett. B **641**, 323 (2006) [arXiv:hep-th/0607183].
- [6] M. Aganagic, C. Beem, J. Seo and C. Vafa, “Geometrically induced metastability and holography,” arXiv:hep-th/0610249.
- [7] M. R. Douglas, J. Shelton and G. Torroba, “Warping and supersymmetry breaking,” arXiv:0704.4001 [hep-th].
- [8] M. Aganagic, C. Beem and S. Kachru, “Geometric Transitions and Dynamical SUSY Breaking,” arXiv:0709.4277 [hep-th].
- [9] M. R. Douglas and G. W. Moore, “D-branes, Quivers, and ALE Instantons,” arXiv:hep-th/9603167.
- [10] I. R. Klebanov and E. Witten, “Superconformal field theory on threebranes at a Calabi-Yau singularity,” Nucl. Phys. B **536**, 199 (1998) [arXiv:hep-th/9807080].

- [11] J. M. Maldacena, “The large N limit of superconformal field theories and supergravity,” *Adv. Theor. Math. Phys.* **2**, 231 (1998) [arXiv:hep-th/9711200].
 E. Witten, “Anti-de Sitter space and holography,” *Adv. Theor. Math. Phys.* **2**, 253 (1998) [arXiv:hep-th/9802150].
 S. S. Gubser, I. R. Klebanov and A. M. Polyakov, “Gauge theory correlators from non-critical string theory,” *Phys. Lett. B* **428**, 105 (1998) [arXiv:hep-th/9802109].
- [12] S. Franco, I. Garcia-Etxebarria and A. M. Uranga, “Non-supersymmetric meta-stable vacua from brane configurations,” *JHEP* **0701**, 085 (2007) [arXiv:hep-th/0607218].
 I. Bena, E. Gorbatov, S. Hellerman, N. Seiberg and D. Shih, “A note on (meta)stable brane configurations in MQCD,” *JHEP* **0611**, 088 (2006) [arXiv:hep-th/0608157].
- [13] A. Giveon and D. Kutasov, “Gauge symmetry and supersymmetry breaking from intersecting branes,” *Nucl. Phys. B* **778**, 129 (2007) [arXiv:hep-th/0703135].
- [14] K. A. Intriligator and S. D. Thomas, “Dual descriptions of supersymmetry breaking,” arXiv:hep-th/9608046.
- [15] K. I. Izawa and T. Yanagida, “Dynamical Supersymmetry Breaking in Vector-like Gauge Theories,” *Prog. Theor. Phys.* **95**, 829 (1996) [arXiv:hep-th/9602180].
- [16] O. Aharony, S. Kachru and E. Silverstein, “Simple Stringy Dynamical SUSY Breaking,” arXiv:0708.0493 [hep-th].
- [17] M. Dine, J. L. Feng and E. Silverstein, “Retrofitting O’Raifeartaigh models with dynamical scales,” *Phys. Rev. D* **74**, 095012 (2006) [arXiv:hep-th/0608159].
- [18] P. B. Kronheimer, “The Construction of ALE spaces as hyperKahler quotients,” *J. Diff. Geom.* **29**, 665 (1989).
- [19] S. Franco, A. Hanany, F. Saad and A. M. Uranga, “Fractional branes and dynamical supersymmetry breaking,” *JHEP* **0601**, 011 (2006) [arXiv:hep-th/0505040].
- [20] S. Franco and A. M. Uranga, “Dynamical SUSY breaking at meta-stable minima from D-branes at obstructed geometries,” *JHEP* **0606**, 031 (2006) [arXiv:hep-th/0604136].

- [21] D. Berenstein, C. P. Herzog, P. Ouyang and S. Pinansky, “Supersymmetry breaking from a Calabi-Yau singularity,” JHEP **0509**, 084 (2005) [arXiv:hep-th/0505029].
- [22] M. Bertolini, F. Bigazzi and A. L. Cotrone, “Supersymmetry breaking at the end of a cascade of Seiberg dualities,” Phys. Rev. D **72**, 061902 (2005) [arXiv:hep-th/0505055].
- [23] K. Intriligator and N. Seiberg, “The runaway quiver,” JHEP **0602**, 031 (2006) [arXiv:hep-th/0512347].
- [24] A. Brini and D. Forcella, “Comments on the non-conformal gauge theories dual to $Y(p,q)$ manifolds,” JHEP **0606**, 050 (2006) [arXiv:hep-th/0603245].
- [25] S. Gubser, N. Nekrasov and S. Shatashvili, “Generalized conifolds and four dimensional $N = 1$ superconformal theories,” JHEP **9905**, 003 (1999) [arXiv:hep-th/9811230].
- [26] A. Amariti, L. Girardello and A. Mariotti, “Meta-stable A_n quiver gauge theories,” arXiv:0706.3151 [hep-th].
- [27] R. Tatar and B. Wetenhall, “Metastable Vacua and Complex Deformations,” arXiv:0707.2712 [hep-th].
- [28] D. R. Morrison and M. R. Plesser, “Non-spherical horizons. I,” Adv. Theor. Math. Phys. **3**, 1 (1999)
- [29] S. Gukov, C. Vafa and E. Witten, “CFT’s from Calabi-Yau four-folds,” Nucl. Phys. B **584**, 69 (2000) [Erratum-ibid. B **608**, 477 (2001)] [arXiv:hep-th/9906070].
- [30] F. Cachazo, K. A. Intriligator and C. Vafa, “A large N duality via a geometric transition,” Nucl. Phys. B **603**, 3 (2001) [arXiv:hep-th/0103067]. R. Dijkgraaf and C. Vafa, “A perturbative window into non-perturbative physics,” arXiv:hep-th/0208048.
- [31] S. B. Giddings, S. Kachru and J. Polchinski, “Hierarchies from fluxes in string compactifications,” Phys. Rev. D **66**, 106006 (2002) [arXiv:hep-th/0105097].
- [32] H. Ooguri and C. Vafa, “Two-Dimensional Black Hole and Singularities of CY Manifolds,” Nucl. Phys. B **463**, 55 (1996) [arXiv:hep-th/9511164].

- [33] A. M. Uranga, “Brane configurations for branes at conifolds,” JHEP **9901**, 022 (1999) [arXiv:hep-th/9811004].
- [34] J. de Boer, K. Hori, H. Ooguri and Y. Oz, “Branes and dynamical supersymmetry breaking,” Nucl. Phys. B **522**, 20 (1998) [arXiv:hep-th/9801060].
- [35] F. Cachazo, B. Fiol, K. A. Intriligator, S. Katz and C. Vafa, “A geometric unification of dualities,” Nucl. Phys. B **628**, 3 (2002) [arXiv:hep-th/0110028].
- [36] S. Imai and T. Yokono, “Comments on orientifold projection in the conifold and SO x USp duality cascade,” Phys. Rev. D **65**, 066007 (2002) [arXiv:hep-th/0110209].
- [37] R. Blumenhagen, M. Cvetič, R. Richter and T. Weigand, “Lifting D-Instanton Zero Modes by Recombination and Background Fluxes,” arXiv:0708.0403 [hep-th].
- [38] R. Argurio, M. Bertolini, G. Ferretti, A. Lerda and C. Petersson, “Stringy Instantons at Orbifold Singularities,” JHEP **0706**, 067 (2007) [arXiv:0704.0262 [hep-th]]. M. Bianchi, F. Fucito and J. F. Morales, “D-brane Instantons on the T^6/Z_3 orientifold,” JHEP **0707**, 038 (2007) [arXiv:0704.0784 [hep-th]].
- [39] L. E. Ibanez, A. N. Schellekens and A. M. Uranga, “Instanton Induced Neutrino Majorana Masses in CFT Orientifolds with MSSM-like spectra,” JHEP **0706**, 011 (2007) [arXiv:0704.1079 [hep-th]]. M. Bianchi and E. Kiritsis, “Non-perturbative and Flux superpotentials for Type I strings on the Z_3 orbifold,” Nucl. Phys. B **782**, 26 (2007) [arXiv:hep-th/0702015]. R. Blumenhagen, M. Cvetič, D. Lust, R. Richter and T. Weigand, “Non-perturbative Yukawa Couplings from String Instantons,” arXiv:0707.1871 [hep-th].
- [40] Z. Chacko, M. A. Luty and E. Ponton, “Calculable dynamical supersymmetry breaking on deformed moduli spaces,” JHEP **9812**, 016 (1998) [arXiv:hep-th/9810253].
- [41] H. Verlinde and M. Wijnholt, “Building the standard model on a D3-brane,” JHEP **0701**, 106 (2007) [arXiv:hep-th/0508089]. M. Buican, D. Malyshev, D. R. Morrison, M. Wijnholt and H. Verlinde, “D-branes at singularities, compactification, and hypercharge,” JHEP **0701**, 107 (2007) [arXiv:hep-th/0610007].

